

Data Sheet



Article number: 12514800140100

Description: KLEE-coil 514 800 140.100
M4 Hardened, zinc-pl. & chr. yellow

Measures

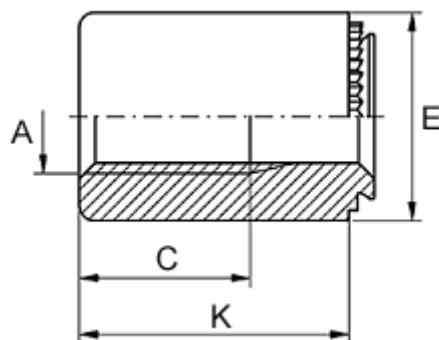

| | |
|---------------------------------|--------------|
| Female thread A | = M4 |
| Height K | = 14 |
| Min distance to edge | = 4.0 |
| Outer diameter E | = 8 |
| Plate thickness | = 1.1 to 1.4 |
| Recommended bore diameter +0.05 | = 5.00 |
| Thread length | = 8.0 |